

## MPS-300A

Integrated, Absolute Pressure Sensor

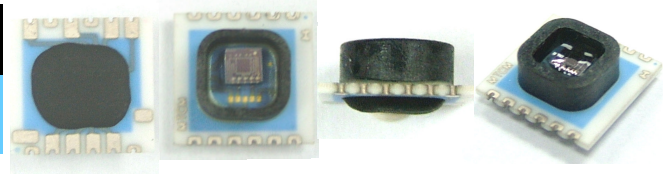

## Integrated, Absolute Pressure Sensor

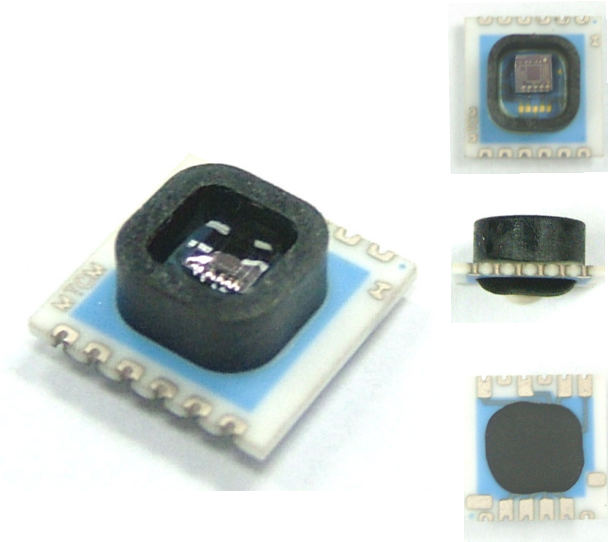

The MPS-300A series pressure sensor is a hybrid device containing an absolute piezoresistive pressure sensing element and an ASIC for signal conditioning. The sensor element is fabricated using bulk micromachining technology.

The ASIC includes temperature and nonlinearity corrections as well as offset and span calibration incorporating a 16 bit digital signal path.

The device is digitally calibrated and tested over temperature to ensure that the relevant accuract and stability performance is met.

Output options include digital interfaces such as SPI and I2C as well as the traditional analogue output that can be interfaced to an external ADC.

Temperature readout is optionally available on digital SPI and I2C interface options.

### FEATURES

- Very low cost
- Excellent repeatability
- 100% factory tested and calibrated
- Stable and reliable
- High volume manufacturing

### THE MAIN FIELD OF APPLICATIONS

- ✓ Mobile altimeter/barometer
- ✓ Weather Forecast
- ✓ Wristwatch
- ✓ Air Balloon
- ✓ Blood Pressure Monitoring

MEMSENZ™ I  
 Transduction Principle  
 Capacitive  
 Processing Technology  
 Bulk/Deep RIE  
 Actuation Mechanism  
 Force (External)  
 Signal Condition  
 Two chips/Single chip

MEMSENZ™ II  
 Transduction Principle  
 Piezoresistive  
 Processing Technology  
 Bulk/Deep Wet Etch  
 Actuation Mechanism  
 Pressure (External)  
 Signal Condition  
 Two chips/Single chip

MEMSENZ™ III  
 Transduction Principle  
 Resistive  
 Processing Technology  
 Surface  
 Actuation Mechanism  
 Thermal  
 Signal Condition  
 Two chips

MEMSENZ™ IV  
 Transduction Principle  
 Capacitive  
 Processing Technology  
 Bulk  
 Actuation Mechanism  
 Sound  
 Signal Condition  
 Two chips

## MPS-300A

Integrated, Absolute Pressure Sensor

### TECHNICAL DATA

Specification	Min.	Typ.	Max.	Unit
Operating Temperature	-20	-	85	°C
Storage Temperature	-30	-	85	°C
Proof Pressure	-	-	500	kPa
	-	-	5000	hPa
	-	-	75	psi
Supply Voltage*	2.7	3.0	3.3	V
	4.75	5.0	5.25	V

\* Note: Both 3V and 5V versions are available. Product is calibrated and tested at 3V unless otherwise specified.

### BASIC PERFORMANCE

Temperature=22±2°C, Relative humidity=45±5%

Specification	Min.	Typ.	Max.	Unit
Supply Current @ 3V	-	3	4	mA
Operating Temperature	-20	-	85	°C
Operating Pressure	30	-	110	kPaA
	300	-	1100	hPaA
	4.35	-	16	psiA
Warm Up Time	-	25	-	ms
Storage Temperature	-30	-	85	°C
Power Supply Capacitor*	100	220	470	nF

\* Note: Power supply capacitor is highly recommended for noise reduction

MEMSENZ™ I  
 Transduction Principle  
 Capacitive  
 Processing Technology  
 Bulk/Deep RIE  
 Actuation Mechanism  
 Force (External)  
 Signal Condition  
 Two chips/Single chip

MEMSENZ™ II  
 Transduction Principle  
 Piezoresistive  
 Processing Technology  
 Bulk/Deep Wet Etch  
 Actuation Mechanism  
 Pressure (External)  
 Signal Condition  
 Two chips/Single chip

MEMSENZ™ III  
 Transduction Principle  
 Resistive  
 Processing Technology  
 Surface  
 Actuation Mechanism  
 Thermal  
 Signal Condition  
 Two chips

MEMSENZ™ IV  
 Transduction Principle  
 Capacitive  
 Processing Technology  
 Bulk  
 Actuation Mechanism  
 Sound  
 Signal Condition  
 Two chips

## MPS-300A

### Integrated, Absolute Pressure Sensor

#### SPI / I2C OUTPUT – INTERFACE OPTIONS S & I

Specification	Min.	Typ.	Max.	Unit
SPI Clock Rate	-	-	1	MHz
Zero Pressure Output (Offset)	-	888	-	Hex
Full Scale Output	-	6666	-	Hex
Full Scale Span	-	5DDE	-	Hex
Accuracy (25 ±3°C & 75-110 kPa)	-	-	±0.3	%FS
Accuracy (0-85°C & 75-110 kPa)	-	-	±0.5	%FS
Pressure Resolution	-	0.02	-	kPa
Sensitivity	-	12C	-	Hex/kPa
	-	1E	-	Hex/hPa
	-	817	-	Hex/psi
Response Time	-	1	5	ms
Temperature Sensing Range	-20	-	85	°C
Temperature Output @ 0 °C		204E		Hex
Temperature Output @ 85 °C		7330		Hex

#### ANALOG OUTPUT – INTERFACE OPTION A

Specification	Min.	Typ.	Max.	Unit
Zero Pressure Output (Offset)	0.178	0.200	0.222	V
Full Scale Output	2.378	2.400	2.422	V
Full Scale Span	-	2.20	-	V
Accuracy (25±3°C & 75-110 kPa)	-	-	± 0.3	%FS
Accuracy (0-85°C & 75-110 kPa)	-	-	± 0.5	%FS
Pressure Resolution	-	0.02	-	kPa
Sensitivity @ 3V	-	36.36	-	mV/kPa
	-	3.36	-	mV/hPa
	-	5.27	-	mV/psi

Typical sensor transfer function (Vcc=3V)

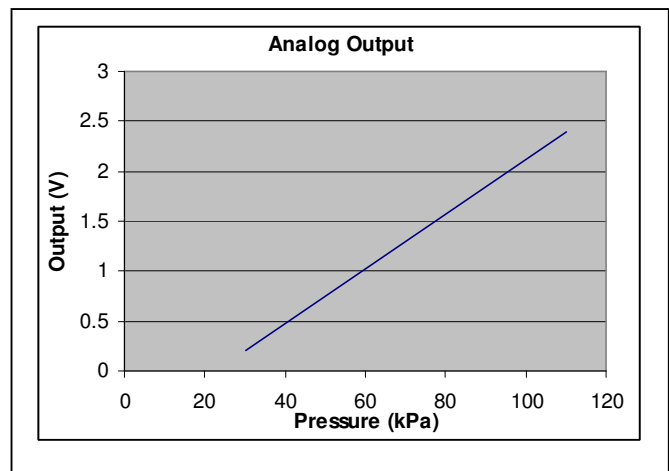

MEMSENZ™ I  
 Transduction Principle  
 Capacitive  
 Processing Technology  
 Bulk/Deep RIE  
 Actuation Mechanism  
 Force (External)  
 Signal Condition  
 Two chips/Single chip

MEMSENZ™ II  
 Transduction Principle  
 Piezoresistive  
 Processing Technology  
 Bulk/Deep Wet Etch  
 Actuation Mechanism  
 Pressure (External)  
 Signal Condition  
 Two chips/Single chip

MEMSENZ™ III  
 Transduction Principle  
 Resistive  
 Processing Technology  
 Surface  
 Actuation Mechanism  
 Thermal  
 Signal Condition  
 Two chips

MEMSENZ™ IV  
 Transduction Principle  
 Capacitive  
 Processing Technology  
 Bulk  
 Actuation Mechanism  
 Sound  
 Signal Condition  
 Two chips

## MPS-300A

Integrated, Absolute Pressure Sensor

### ELECTRICAL & PIN LAYOUT

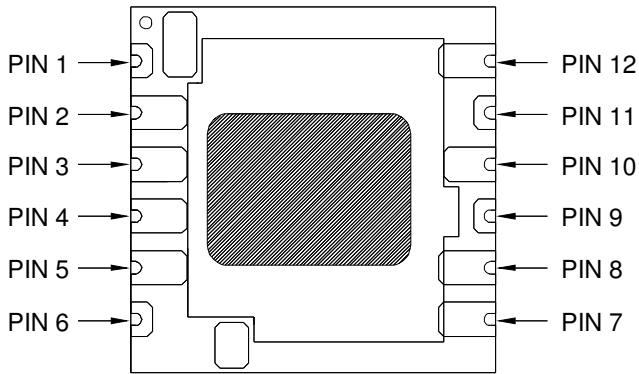

Pad	Symbol	Description
1	NC	No Connect
2	IO1	SPI data out (Interface Option S)
3	IO2	SPI chip select (Interface Option S)
4	SCL	I <sup>2</sup> CLK & SPI Clock (Interface Options I & S)
5	SDA	Data I/O for I <sup>2</sup> C & data in for SPI (Interface Options I & S)
6	NC	No Connect
7	Vdd	Power Supply Positive Connection
8	Vss	Power Supply Negative Connection
9	NC	No Connect
10	OUT	Analogue output
11	NC	No Connect
12	Vss	Power Supply Negative Connection

MEMSENZ™ I  
 Transduction Principle  
 Capacitive  
 Processing Technology  
 Bulk/Deep RIE  
 Actuation Mechanism  
 Force (External)  
 Signal Condition  
 Two chips/Single chip

MEMSENZ™ II  
 Transduction Principle  
 Piezoresistive  
 Processing Technology  
 Bulk/Deep Wet Etch  
 Actuation Mechanism  
 Pressure (External)  
 Signal Condition  
 Two chips/Single chip

MEMSENZ™ III  
 Transduction Principle  
 Resistive  
 Processing Technology  
 Surface  
 Actuation Mechanism  
 Thermal  
 Signal Condition  
 Two chips

MEMSENZ™ IV  
 Transduction Principle  
 Capacitive  
 Processing Technology  
 Bulk  
 Actuation Mechanism  
 Sound  
 Signal Condition  
 Two chips

## MPS-300A

### Integrated, Absolute Pressure Sensor

#### SPECIFICATION NOTES

1. Operating and storage temperature to strictly not exceed stated values.
2. Pressure unit conversion --- 1 atm=101.325 kPa=1013.25 hPa=14.504 psi.
3. Operating pressure and temperature. The nominal pressure under which the device can be exposed under normal operating conditions. Unless explicitly stated, other specifications are rated over the operating pressure and temperature ranges.
4. Proof pressure and temperature. The extremes of temperature and pressure that the device can withstand without performance degradation.
5. Supply Voltage is the nominal operating voltage. The device output is ratio metric (scales with the supply) within the stated range.
6. Stated Warm up time is a recommended time after power up before measurement stability is reached within the rated accuracy range.
7. All outputs are measured with a nominal 4.7k load on the output pin, and with the power supply decoupled by 16uF electrolytic / 0.1uF ceramic capacitor pair, with an applied power supply within 5mV of the nominal value at temperature of T=25±5°C
8. Accuracy represents the expected deviation of the sensor value from the ideal linear behavior over temperature and pressure, and includes thermal and pressure linearity and hysteresis effects over the life of the sensor. This is validated using accelerated aging techniques such as high temperature biased life, thermal cycling and thermal and pressure cycling tests.
9. Offset stability represents the proportion of the deviation in offset (zero pressure output) at fixed temperature T=25±5°C, over the life of the sensor, and includes the effects of thermal and pressure hysteresis as well as other sources of drift.
10. Device operating lifetime is verified using accelerated aging techniques.

#### PRODUCT OPTIONS

Option	Interface	Calibration Power Supply	Parameters available for readout
A	Analogue	3V	Pressure
A5	Analogue	5V	Pressure
I	Digital I <sup>2</sup> C	3V	Pressure
I5	Digital I <sup>2</sup> C	5V	Pressure
IT	Digital I <sup>2</sup> C	3V	Pressure and Temperature
IT5	Digital I <sup>2</sup> C	5V	Pressure and Temperature
S	Digital SPI	3V	Pressure
S5	Digital SPI	5V	Pressure
ST	Digital SPI	3V	Pressure and Temperature
ST5	Digital SPI	5V	Pressure and Temperature

MEMSENZ™ I  
 Transduction Principle  
 Capacitive  
 Processing Technology  
 Bulk/Deep RIE  
 Actuation Mechanism  
 Force (External)  
 Signal Condition  
 Two chips/Single chip

MEMSENZ™ II  
 Transduction Principle  
 Piezoresistive  
 Processing Technology  
 Bulk/Deep Wet Etch  
 Actuation Mechanism  
 Pressure (External)  
 Signal Condition  
 Two chips/Single chip

MEMSENZ™ III  
 Transduction Principle  
 Resistive  
 Processing Technology  
 Surface  
 Actuation Mechanism  
 Thermal  
 Signal Condition  
 Two chips

MEMSENZ™ IV  
 Transduction Principle  
 Capacitive  
 Processing Technology  
 Bulk  
 Actuation Mechanism  
 Sound  
 Signal Condition  
 Two chips

## MPS-300A

### Integrated, Absolute Pressure Sensor

#### I<sup>2</sup>C Interface Description (Option I)

For I<sup>2</sup>C communication only two pins are used namely SDA (Pin 5) and SCL (Pin 4). The sensor behaves as a slave in this communication.

The I<sup>2</sup>C protocol is defined as follows:

- i) Idle period : During inactivity the SDA and SCL are pulled to supply voltage Vdd
- ii) Start Condition: A high to low transition on SDA while SCL is high indicates a start condition. Every command has to be initiated by a start condition sent by the master. A master can always generate a start condition
- iii) Stop Condition: A low to high transition on SDA while SCL is high indicates a stop condition. A command has to be closed by a stop condition to start processing the command routine inside the Sensor

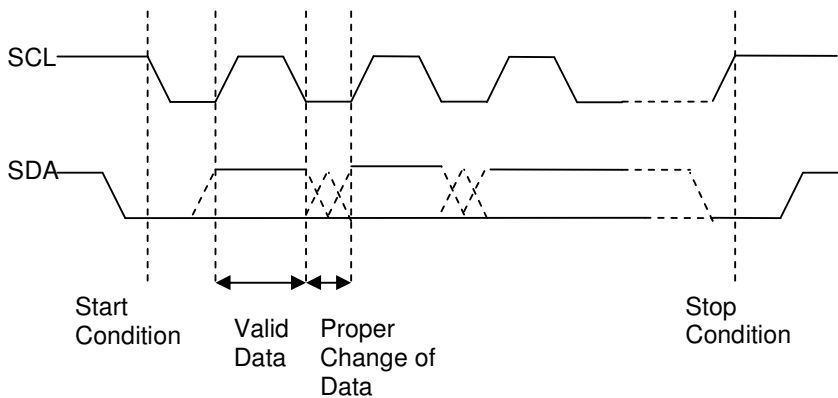

- iv) Valid Data: Data is transmitted in bytes (8 bits), MSB first. SDA transmits the data, while SCL clocks the data. Each byte transmitted is followed by an acknowledge bit. A bit is transferred by pulling SCL low, placing the data on SDA, then clocking SCL from high to low. Transmitted bits are valid after a start condition only if SDA keeps at constant level during the high period of SCL. The SDA level has to change only when clock signal SCL is low.
- v) Acknowledge Bit: Acknowledge after a transmitted byte is necessary. The transmitting device must generate an acknowledge related clock pulse. The receiver (slave or master) pulls down the SDA line during the acknowledge clock pulse. If no acknowledge is generated by the receiver the transmitting device will become inactive. A transmitting master can abort the transmission by generating a stop condition and may repeat the command.
- vi) Addressing: the slave address of the sensor is hard wired 7 bit address 0x78. This address cannot be changed. The master sends the address byte containing the 7 bit slave address followed by a read/write byte. '1' indicates a read and '0' indicates a write. The write operation is used exclusively by the manufacturer for calibration purposes and should not be used by the customer.
- vii) Read Operation: After power on the master should send a read request to the sensor according to the figure below. The master must generate the transmission clock on SCL and followed by the acknowledge bit for each data byte except the last which is sent by the sensor.

## MPS-300A

Integrated, Absolute Pressure Sensor

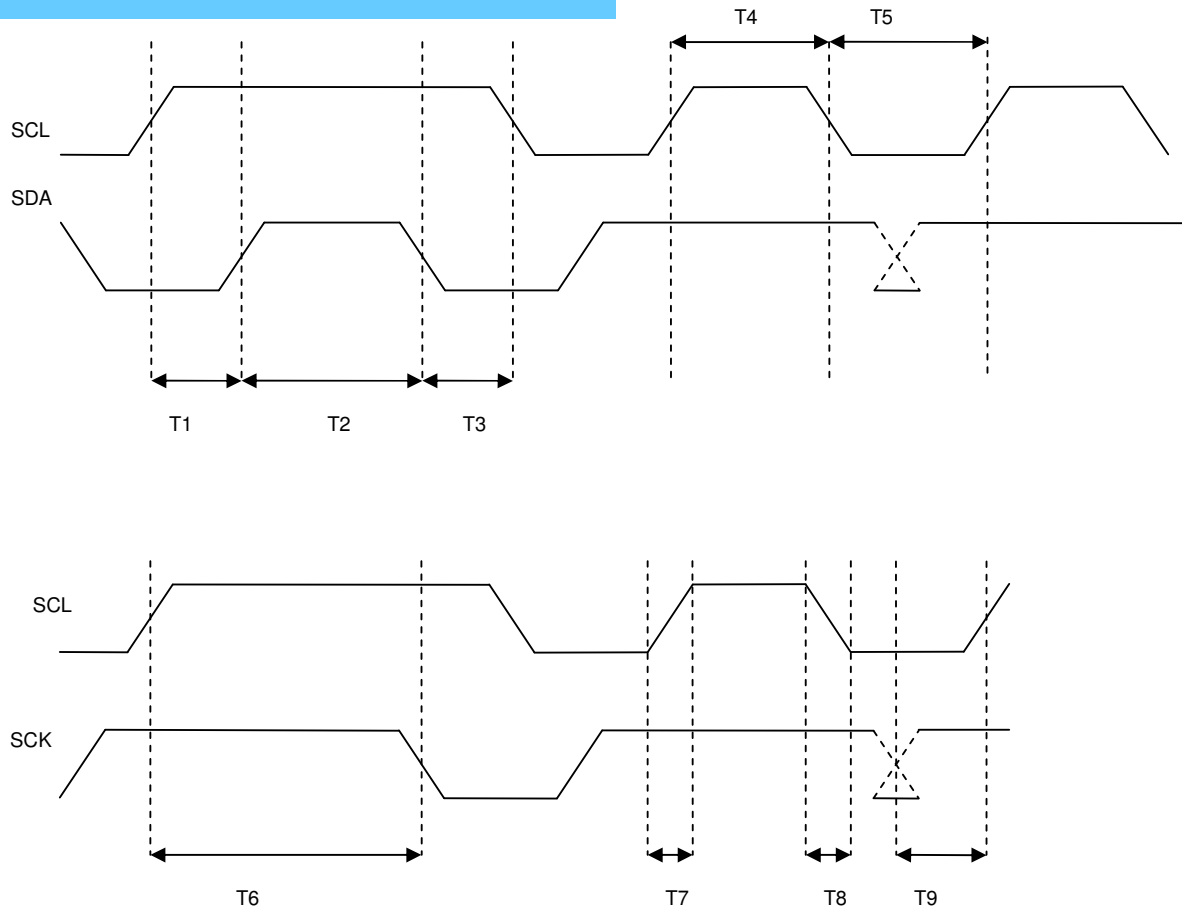

### TIMING SPECIFICATIONS (I<sup>2</sup>C INTERFACE)

Parameter	Symbol	Min	Typ	Max	Unit
SCL Clock Frequency	$f_{scl}$	-	-	400	kHz
Bus Free time between start and stop condition	T2	1.3	-	-	$\mu$ s
Hold Time Start Condition	T3	0.6	-	-	$\mu$ s
High Period SCL/SDA	T4	1.3	-	-	$\mu$ s
Low Period SCL/SDA	T5	1.3	-	-	$\mu$ s
Setup Time Stop Condition	T1	0.6	-	-	$\mu$ s
Setup Time Repeated Start Condition	T6	0.6	-	-	$\mu$ s
Rise Time SCL/SDA	T7	0.3	-	-	$\mu$ s
Fall Time	T8	0.3	-	-	$\mu$ s
Data Setup Time	T9	0.1	-	-	$\mu$ s

MEMSENZ™ I  
 Transduction Principle  
 Capacitive  
 Processing Technology  
 Bulk/Deep RIE  
 Actuation Mechanism  
 Force (External)  
 Signal Condition  
 Two chips/Single chip

MEMSENZ™ II  
 Transduction Principle  
 Piezoresistive  
 Processing Technology  
 Bulk/Deep Wet Etch  
 Actuation Mechanism  
 Pressure (External)  
 Signal Condition  
 Two chips/Single chip

MEMSENZ™ III  
 Transduction Principle  
 Resistive  
 Processing Technology  
 Surface  
 Actuation Mechanism  
 Thermal  
 Signal Condition  
 Two chips

MEMSENZ™ IV  
 Transduction Principle  
 Capacitive  
 Processing Technology  
 Bulk  
 Actuation Mechanism  
 Sound  
 Signal Condition  
 Two chips

## MPS-300A

Integrated, Absolute Pressure Sensor

### SPI INTERFACE DESCRIPTION – OPTIONS

#### SPI Pin Signals

There are four I/O signals associated with SPI transfers: SCK (pin 4), MISO (pin 2), MOSI (used by the manufacturer for calibration purposes only) and SS (pin 3). SCK is an input pin for the clock signal from the master which synchronizes the data transfer between the master and slave devices. Slave devices ignore the SCK signal unless the SS pin is active low. Data is shifted on the rising edge of the SCK signal and is sampled on the opposite edge where the data is stable.

The MISO and MOSI data pins are used for transmitting and receiving serial data. For the slave the MOSI is the data input line and the MISO is the data output line. Once selected by the master the slave optionally drives data out its MOSI pin to the MISO of the master. The MOSI pin of the MTCM is solely for manufacturer's use and the customer is advised to disconnect this in their application.

The SS pin is used by the master to enable the SPI slave for a transfer. If the SS pin of a slave is inactive (High), the device ignores SCK clocks and keeps the MISO output pin in a high impedance state. The MBAP is always the slave and it is assumed in most cases the master is a microcontroller (MCU).

#### READING THE PRESSURE AND TEMPERATURE (OPTION ST)

To read the pressure/temperature value, power up the device and wait for > 25ms. After that read the data from the MISO pin. Five bytes have to be read out. MSB is transmitted first. The first byte is a dummy byte always set to 0xFF. For the second and fourth byte only the last seven bits should be considered with the eighth bit (the MSB) always set to binary 0. The third and fifth byte should be read as normal, MSB first. The pressure and temperature results are both 15 bit binary words. The second and third byte make up the 15 bit pressure word and the fourth

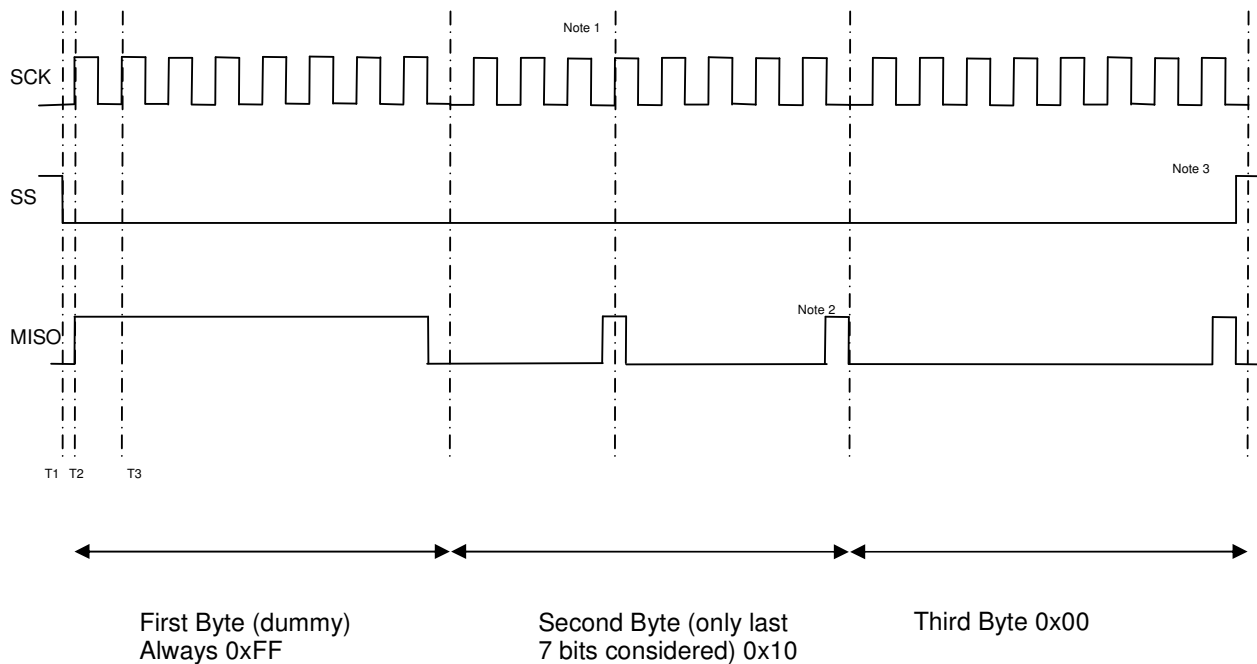

MEMSENZ™ I  
 Transduction Principle  
 Capacitive  
 Processing Technology  
 Bulk/Deep RIE  
 Actuation Mechanism  
 Force (External)  
 Signal Condition  
 Two chips/Single chip

MEMSENZ™ II  
 Transduction Principle  
 Piezoresistive  
 Processing Technology  
 Bulk/Deep Wet Etch  
 Actuation Mechanism  
 Pressure (External)  
 Signal Condition  
 Two chips/Single chip

MEMSENZ™ III  
 Transduction Principle  
 Resistive  
 Processing Technology  
 Surface  
 Actuation Mechanism  
 Thermal  
 Signal Condition  
 Two chips

MEMSENZ™ IV  
 Transduction Principle  
 Capacitive  
 Processing Technology  
 Bulk  
 Actuation Mechanism  
 Sound  
 Signal Condition  
 Two chips



## MPS-300A

Integrated, Absolute Pressure Sensor

Parameter	Description	Min	Typ	Max
T1-T2	SS delay before first SCK Pulse	1µs	-	-
T2-T3	SCK Clock Period	1µs	-	-

Note 1: Data must be sampled on the rising edge of the SCK

Note 2: There will be a dummy pulse starting from the middle of the 7<sup>th</sup>, 15<sup>th</sup> and 23<sup>rd</sup> SCK pulses lasting until after the next falling edge of the SCK. This pulse should be ignored.

Note 3: At the end of the transfer (24 clocks) the SS must be reasserted (brought high then low again) to begin another transfer.

### Converting Digital Values to Engineering Units (SPI and I2C)

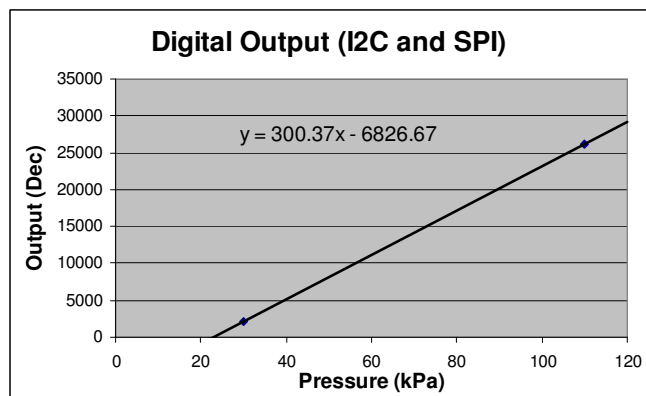

Conversion of Digital value to Engineering Units:

1. Digital value decimal
2. Add 6826.67
3. Divide by 300.37
4. result is in kPa

The chart at the left shows the transfer function used to calibrate the Digital output of the sensor pressure reading.

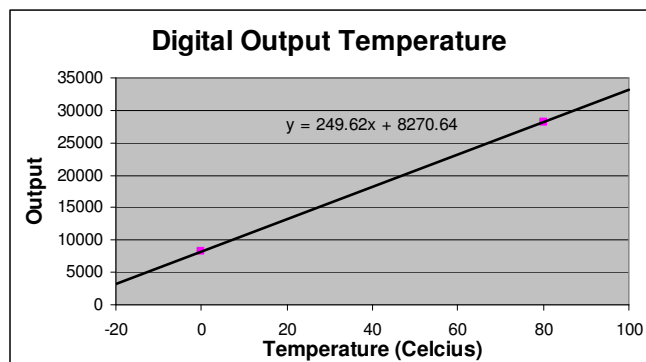

Conversion of Digital value to Engineering Units:

5. Digital value decimal
6. Subtract 8270.64
7. Divide by 249.62
8. result is in C

The chart at the left shows the transfer function used to calibrate the Digital output of the sensor temperature reading.

## MPS-300A

Integrated, Absolute Pressure Sensor

### PHYSICAL DIMENSIONS (9mm by 9mm, square cap)

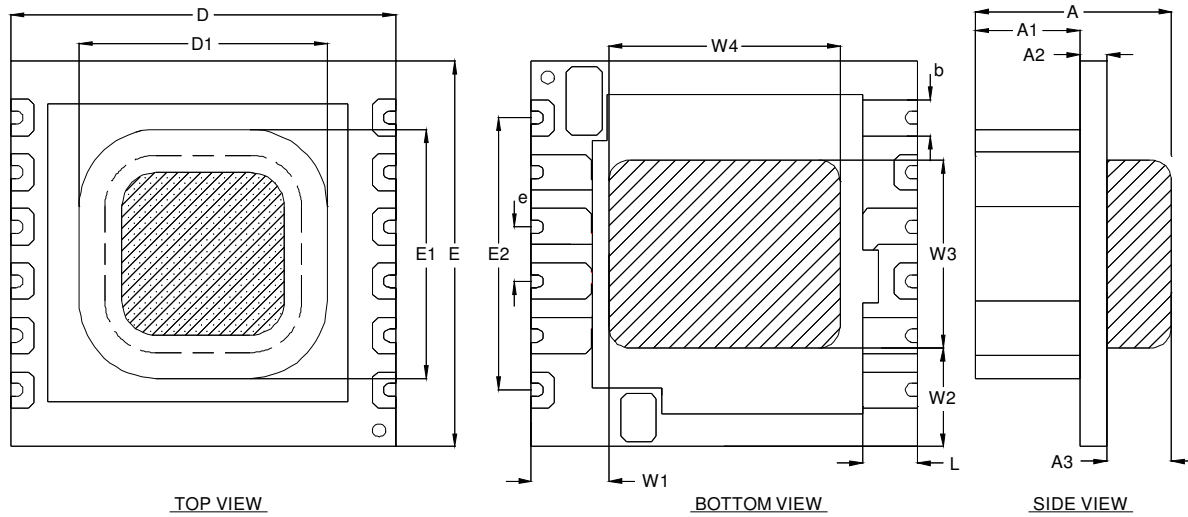

SYMBOLS	MILLIMETER			INCHES		
	e = 1.27mm BASIC			e = 0.050" BASIC		
	MINIMUM	NOMINAL	MAXIMUM	MINIMUM	NOMINAL	MAXIMUM
A	4.372	4.535	4.698	0.1721	0.1785	0.1850
A1	2.350	2.400	2.450	0.0925	0.0945	0.0965
A2	0.572	0.635	0.698	0.0225	0.0250	0.0275
A3	1.450	1.500	1.550	0.0571	0.0591	0.0611
b	0.788	0.838	0.888	0.0310	0.0330	0.0350
D	8.950	9.000	9.050	0.3520	0.3540	0.3560
D1	5.750	5.800	5.850	0.2263	0.2283	0.2303
E	8.950	9.000	9.050	0.3520	0.3540	0.3560
E1	5.750	5.800	5.850	0.2263	0.2283	0.2303
E2	---	6.350	---	---	0.2500	---
L	1.220	1.270	1.320	0.0480	0.0500	0.0520
W1	1.750	1.800	1.850	0.0690	0.0709	0.0728
W2	2.250	2.300	2.350	0.0886	0.0906	0.0925
W3	4.342	4.392	4.442	0.1709	0.1729	0.1750
W4	5.342	5.392	5.442	0.2103	0.2123	0.2143

MEMSENZ™ I  
 Transduction Principle  
 Capacitive  
 Processing Technology  
 Bulk/Deep RIE  
 Actuation Mechanism  
 Force (External)  
 Signal Condition  
 Two chips/Single chip

MEMSENZ™ II  
 Transduction Principle  
 Piezoresistive  
 Processing Technology  
 Bulk/Deep Wet Etch  
 Actuation Mechanism  
 Pressure (External)  
 Signal Condition  
 Two chips/Single chip

MEMSENZ™ III  
 Transduction Principle  
 Resistive  
 Processing Technology  
 Surface  
 Actuation Mechanism  
 Thermal  
 Signal Condition  
 Two chips

MEMSENZ™ IV  
 Transduction Principle  
 Capacitive  
 Processing Technology  
 Bulk  
 Actuation Mechanism  
 Sound  
 Signal Condition  
 Two chips

## MPS-300A

Integrated, Absolute Pressure Sensor

### HOW TO SPECIFY PART NUMBER

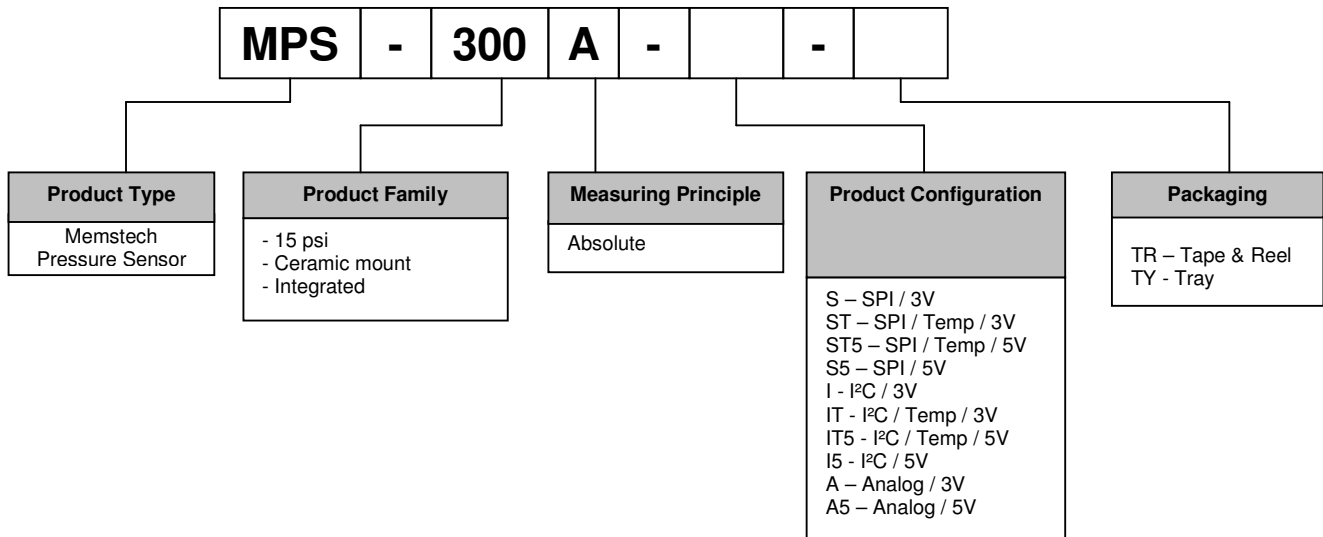

USA **Srini Naidu** Executive Director, 42503 Steeple View, Northville MI 48167 **Tel:** 734 560 5506 **Fax:** 734 420 3004 **Email:** [srini@memstech.com](mailto:srini@memstech.com)

WORLDWIDE **Bryan Bryan K Patmon** Chief Marketing Officer **Email:** [bkpatmon@memstech.com](mailto:bkpatmon@memstech.com)  
 Singapore: 85, Science Park Drive, #01-02/02, The Cavendish, Singapore 118259. **Tel:** +65-6822 6889 **Fax:** +65-6779 3711 **Email:** [bkpatmon@memstech.com](mailto:bkpatmon@memstech.com)  
 Malaysia: PTD 43005 Jalan Perindustrian Murni 11, Taman Perindustrian Murni, 81400 Senai, Johor, Malaysia **Tel:** +607- 5996323 **Fax:** +607- 598 6388

Website: [www.memstech.com](http://www.memstech.com)

#### SALES TERMS:

MemsTech's Standard Sales Terms apply. Price and specifications are subject to change without notice.

#### WARRANTY:

Subject to the conditions set out below in this Clause, MemsTech and its subsidiaries warrants its products against defects in material and workmanship for a period of 12 months from the date of shipment. Products that are not subjected to misuse will be repaired or replaced. MemsTech and its subsidiaries reserves the right to make changes to any product herein without further notice. MemsTech and its subsidiaries makes no warranty, representation or guarantee regarding the suitability of its products for any application, nor does MemsTech and its subsidiaries assume liability arising out of the application or use of any product or circuit and specifically disclaims all liability without limitation consequential or incidental damages. The foregoing warranties are exclusive and in lieu of all other warranties, whether written, oral, implied or statutory. NO IMPLIED STATUTORY WARRANTY OF MERCHANTABILITY OR FITNESS FOR A PARTICULAR PURPOSE SHALL APPLY. This warranty does not extend to parts, materials or equipment not manufactured by MemsTech and its subsidiaries and this warranty is further subject to the conditions that MemsTech and its subsidiaries shall be under no liability whatsoever in respect of any defect in the products arising from any drawing design or specification supplied by the buyer or any defect arising from fair wear and tear, wilful damage, negligence, abnormal working conditions, failure to follow MemsTech and its subsidiaries' instructions (whether oral or in writing), misuse or alteration or repair of the products without MemsTech and its subsidiaries' approval. The provisions herein are governed by the laws of Malaysia.

**MEMSENZ™ I**  
 Transduction Principle  
 Capacitive  
 Processing Technology  
 Bulk/Deep RIE  
 Actuation Mechanism  
 Force (External)  
 Signal Condition  
 Two chips/Single chip

**MEMSENZ™ II**  
 Transduction Principle  
 Piezoresistive  
 Processing Technology  
 Bulk/Deep Wet Etch  
 Actuation Mechanism  
 Pressure (External)  
 Signal Condition  
 Two chips/Single chip

**MEMSENZ™ III**  
 Transduction Principle  
 Resistive  
 Processing Technology  
 Surface  
 Actuation Mechanism  
 Thermal  
 Signal Condition  
 Two chips

**MEMSENZ™ IV**  
 Transduction Principle  
 Capacitive  
 Processing Technology  
 Bulk  
 Actuation Mechanism  
 Sound  
 Signal Condition  
 Two chips